

(P0132x-03)









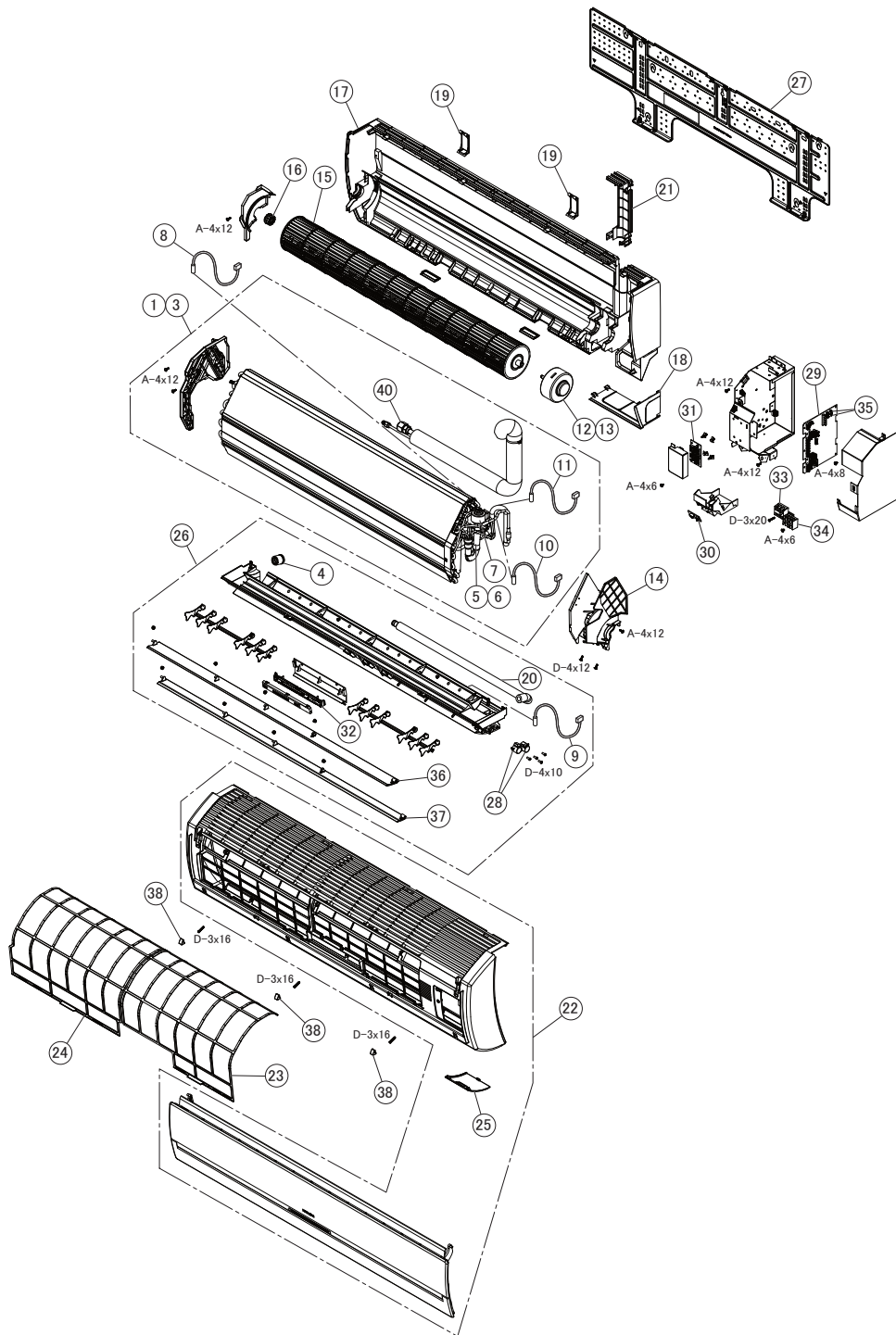

Voltage
1~230V/50Hz

No.	Part Name	Replacement Part		Remarks	Q'ty Per Unit			
		Draw. No.	Order No.		RPK-2.0FSN3M	RPK-2.5FSN3M	RPK-3.0FSN3M	RPK-4.0FSN3M
1	Heat Exchanger	17A23587A	P29638		1			
2								
3	Heat Exchanger	17A23537A	P29596			1	1	1
4	Drain Cap	17C88465A	P27062		1	1	1	1
5	Expansion Valve	17F04391A	P28701	Fujikoki Corporation, PAM-B40YGHS-1	1			
6	Expansion Valve	17F04392A	P28702	Fujikoki Corporation, PAM-B80YGHS-1		1	1	1
7	Motor for EXPV	17F04390G	P29630	Fujikoki Corporation, PAM-MD12HS-11	1	1	1	1
8	Thermistor	17B24598C	P24016	THM1 for Air Inlet	1	1	1	1
9	Thermistor	17B38999A	P29626	THM2 for Air Outlet	1	1	1	1
10	Thermistor	17B42636D	P29628	THM3 for Freeze Protection	1	1	1	1
11	Thermistor	17B42635D	P29627	THM5 for Gas Line	1	1	1	1
12	Fan Motor	17B37604C	P27063	DC, 38W	1	1	1	
13	Fan Motor	17A23557A	P29597	DC, 38W				1
14	Motor Clamp	17A18031A	P27064		1	1	1	1
15	Fan	17A18032A	P27065		1	1	1	1
16	Bearing	17C88466A	P27066		1	1	1	1
17	Cabinet Assy	17A23538A	P29598		1	1	1	1
18	Corner Cover	17A18034B	P27332		1	1	1	1
19	Pipe Fixing Plate	17B37605A	P27069		2	2	2	2
20	Drain Hose	17B37606A	P27070		1	1	1	1
21	Pipe Cover	17A18035B	P27333		1	1	1	1
22	Cabinet Panel Assy	17A23588A	P29639		1	1	1	1
23	Filter	17A18037A	P27073	for Right Side	1	1	1	1
24	Filter	17A18038A	P27074	for Left Side	1	1	1	1
25	Receiver Cover	17F11791A	P29640		1	1	1	1
26	Drain Pan Assy	17A23540A	P29601		1	1	1	1
27	Plate	17A23541A	P29602		1	1	1	1
28	AS Motor	17A18041A	P27077	for Auto Swing Louver	2	2	2	2
29	PCB-S	17H18655B	P29518	PI-121-S for Control	1	1	1	1
30	PCB-S	17F11641A	P29603	for Receiver	1	1	1	1
31	PCB-S	17H18656A	P29519	for Switch	1	1	1	1
32	PCB-S	17A18042A	P27080	for Indicator	1	1	1	1
33	Terminal Board	17C85280A	P26616	for Power Source Circuit	1	1	1	1
34	Terminal Board	17C85281A	P26618	for Control Circuit	1	1	1	1
35	Fuse	17C90851A	P27957	Fuse on PI-121-S, 5A	2	2	2	2
36	Horizontal Blade	17A23543A	P29604		1	1	1	1
37	Horizontal Blade	17A23544A	P29605		1	1	1	1
38	Screw Cap	17B37608A	P27079		3	3	3	3
39								
40	Flare Nut	17E20872D	R4227	φ15.88	1	1	1	1

NOTE:

The parts without order number are the custom-ordered, and these are not mentioned in the price list.
When ordering them, the part name and the drawing number are required.
Contact your HITACHI distributor for the delivery date and price about them.



A	Truss Head Tapping Screw		F	Stud Bolt	
B	Round Head Screw		G	Nut	
C	Flat Head Screw		H	Washer	
D	Pan Head Tapping Screw		J	Spring Lock Washer	
E	Hexagon Head Bolt		K	Toothed Lock Washer	

NOTE:
The uncoated coating is applied to iron and steel material for the unspecified materials of the bolt and screw.

NOTE:
The parts without order number are the custom-ordered, and these are not mentioned in the price list. When ordering them, the part name and the drawing number are required. Contact your HITACHI distributor for the delivery date and price about them.